



## Power Amplifier



## MC501 Owner's Manual

The lightning flash with arrowhead, within an equilateral triangle, is intended to alert the user to the presence of uninsulated "dangerous voltage" within the product's enclosure that may be of sufficient magnitude to constitute a risk of electric shock to persons.



**AVIS** RISQUE DE CHOC ELECTRIQUE - NE PAS OUVRIR.

The exclamation point within an equilateral triangle is intended to alert the user to the presence of important operating and maintenance (servicing) instructions in the literature accompanying the appliance.

**WARNING - TO REDUCE RISK OF FIRE OR ELECTRICAL SHOCK, DO NOT EXPOSE THIS EQUIPMENT TO RAIN OR MOISTURE.**

**NO USER-SERVICEABLE PARTS INSIDE. REFER SERVICING TO QUALIFIED PERSONNEL.**

To prevent the risk of electric shock, do not remove cover or back. No user serviceable parts inside.

## IMPORTANT SAFETY INSTRUCTIONS!

**PLEASE READ THEM BEFORE OPERATING THIS EQUIPMENT.**

1. Read these instructions.
2. Keep these instructions.
3. Heed all warnings.
4. Follow all instructions.
5. Do not use this apparatus near water.
6. Clean only with a dry cloth.
7. Do not block any ventilation openings. Install in accordance with the manufacturer's instructions.
8. Do not install near any heat sources such as radiators, heat registers, stoves, or other apparatus (including amplifiers) that produce heat.
9. Do not defeat the safety purpose of the polarized or grounding-type plug. A polarized plug has two blades with one wider than the other. A grounding type plug has two blades and a third grounding prong. The wide blade or the third prong are provided for your safety. If the provided plug does not fit into your outlet, consult an electrician for replacement of the obsolete outlet.
10. Protect the power cord from being walked on or pinched particularly at plugs, convenience receptacles, and the point where they exit from the apparatus.
11. Only use attachments/accessories specified by the manufacturer.
12. Use only with the cart, stand, tripod, bracket, or table specified by the manufacturer, or sold with the apparatus. When a cart is used, use caution when moving the cart/apparatus combination to avoid injury from tip-over. 
13. Unplug this apparatus during lightning storms or when unused for long periods of time.
14. Refer all servicing to qualified service personnel. Servicing is required when the apparatus has been damaged in any way, such as power-supply cord or plug is damaged, liquid has been spilled or objects have fallen into the apparatus, the apparatus has been exposed to rain or moisture, does not operate normally, or has been dropped.
15. Do not expose this equipment to dripping or splashing and ensure that no objects filled with liquids, such as vases, are placed on the equipment.
16. To completely disconnect this equipment from the a.c. mains, disconnect the power supply cord plug from the a.c. receptacle.
17. The mains plug of the power supply cord shall remain readily operable.

---

## Thank You

Your decision to own this McIntosh MC501 Power Amplifier ranks you at the very top among discriminating music listeners. You now have “The Best.” The McIntosh dedication to “Quality,” is assurance that you will receive many years of musical enjoyment from this unit.

Please take a short time to read the information in this manual. We want you to be as familiar as possible with all the features and functions of your new McIntosh.

---

## Please Take A Moment

The serial number, purchase date and McIntosh Dealer name are important to you for possible insurance claim or future service. The spaces below have been provided for you to record that information:

**Serial Number:** \_\_\_\_\_

**Purchase Date:** \_\_\_\_\_

**Dealer Name:** \_\_\_\_\_

---

## Technical Assistance

If at any time you have questions about your McIntosh product, contact your McIntosh Dealer who is familiar with your McIntosh equipment and any other brands that may be part of your system. If you or your Dealer wish additional help concerning a suspected problem, you can receive technical assistance for all McIntosh products at:

McIntosh Laboratory, Inc.  
2 Chambers Street  
Binghamton, New York 13903  
Phone: 607-723-1545  
Fax: 607-723-3636

---

## Customer Service

If it is determined that your McIntosh product is in need of repair, you can return it to your Dealer. You can also return it to the McIntosh Laboratory Service Department. For assistance on factory repair return procedure, contact the McIntosh Service Department at:

McIntosh Laboratory, Inc.  
2 Chambers Street  
Binghamton, New York 13903  
Phone: 607-723-3515  
Fax: 607-723-1917

---

## Table of Contents

Safety Instructions .....	2
Thank You and Please Take a Moment .....	3
Technical Assistance and Customer Service .....	3
Table of Contents and General Notes .....	3
Connector Information .....	4
Introduction .....	4
Performance Features .....	4
Dimensions .....	5
Installation .....	6
Top Panel Connections and Switch .....	7
How to Connect .....	8
Front Panel Displays and Controls .....	10
How to Operate .....	11
Technical Description .....	12
Notes .....	16
Specifications .....	18
Packing Instruction .....	19

---

## Important Information

**Caution: The MC501 Amplifier weight is 91.5 pounds (41.5 kilograms). It requires two or more persons to safely handle when moving the amplifier.**

1. The following Connecting Cable is available from the McIntosh Parts Department:  
**Power Control Cable Part No. 170-202**  
Six foot, 2 conductor shielded, with two 1/8 inch stereo mini phone plugs.
2. For additional connection information, refer to the owner's manual(s) for any component(s) connected to the MC501.
3. The MC501 mutes the speaker output for approximately two seconds when first turned on.
4. It is very important that loudspeaker cables of adequate size be used, so that there will be no power loss. The size is specified in Gauge Numbers or AWG, (American Wire Gauge). The smaller the Gauge number, the larger the wire size:  
If your loudspeaker cables are 50 feet (38.1m) or less, use at least 14 Gauge.  
If your loudspeaker cables are 100 feet (76.2m) or less, use at least 12 Gauge.
5. In the event the MC501 over heats, due to improper ventilation and/or high ambient temperature, the protection circuits will activate. The Power Guard LED will stay ON and the audio will be muted. When the MC501 has returned to a safe operating temperature, normal operation will resume.
6. The MC501 incorporates Fully Double Balanced Circuitry. As a result, the Loudspeaker ⊖ Negative Connections are above chassis ground. Do not combine any connections together, ground them or connect with another MC501.

## Connector Information

### XLR Connectors

Below is the Pin configuration for the XLR Balanced Input and Output Connectors on the MC501. Refer to the diagram for connection:

- PIN 1: Shield/Ground
- PIN 2: + Input
- PIN 3: - Input



### Power Control and Trigger Connectors

The MC501's Power Control Outputs provide a 5 volt signal. Use a 1/8 inch stereo mini phone plug to connect to the Power Control Input on other McIntosh Components.

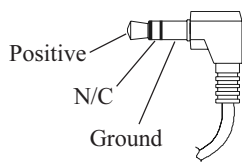

## Introduction

Now you can take advantage of traditional McIntosh standards of excellence in the MC501 Power Amplifier. The 500 watt high current output will drive any high quality Loudspeaker System to its ultimate performance. The MC501 reproduction is sonically transparent and absolutely accurate. The McIntosh Sound is "The Sound of the Music Itself."

## Performance Features

### ● Power Output

The MC501 is a Power Amplifier with a capability of 500 watts into 2, 4 or 8 ohm speakers with less than 0.005% distortion.

### ● Full Balanced Quad-Differential Circuitry

The MC501 is fully balanced from inputs to outputs. It consists of two matched power amplifiers operating in push-pull with their outputs combined in a McIntosh Autoformer. The double balanced configuration cancels virtually all distortion.

### ● Patented Autoformers

The McIntosh designed and manufactured Output Autoformer provides an ideal match between the amplifier output stage and speaker loads of 2, 4 and 8 ohms. The Autoformer also provides perfect DC protection for your valuable Loudspeaker.

### ● Patented Power Guard

The patented McIntosh Power Guard Circuit prevents the amplifier from being over driven into clipping, with its

harsh distorted sound that can also damage your valuable Loudspeaker.

### ● Patented Sentry Monitor with Thermal Protection

McIntosh Sentry Monitor power output stage protection circuits ensure the MC501 will have a long and trouble free operating life. Built-in Thermal Protection Circuits guard against overheating.

### ● Power Control

The McIntosh Power Control Circuit allows for remote turn-on of the MC501 Power Amplifier from a McIntosh Audio/Video Control Center or Preamplifier. If any additional McIntosh Power Amplifiers are part of the system, a delayed Power Control Output Trigger is available. This delayed trigger reduces the strain on the house's electrical wiring and protection devices.

### ● Balanced and Unbalanced Inputs

Balanced connections guard against induced noise and allow long cable runs without compromising sound quality.

### ● Illuminated Power Meter

The Illuminated Power Output Watt Meter on the MC501 is peak responding, and indicates the true power output of the amplifier. The Peak Watt Hold Mode allows the meter to temporarily stay at the highest power output and then slowly decay. The Front Panel Meter Illumination may be switched Off at any time.

### ● Fiber Optic Solid State Front Panel Illumination

The Illumination of the Front Panel is accomplished by the combination of custom designed Fiber Optic Light Diffusers and Light Emitting Diodes (LEDs). This provides even Front Panel Illumination, together with the extra long life LEDs.

### ● Glass Front Panel and Super Mirror Chassis Finish

The famous McIntosh Illuminated Glass Front Panel with a three dimensional look and the Stainless Steel Chassis with Super Mirror Finish ensures the pristine beauty of the MC501 will be retained for many years.

## Connector Information, Introduction, Performance Features and Dimensions

The following dimensions can assist in determining the best location for your MC501. There is additional information on the next page pertaining to installing the MC501 into cabinets.

**Front View of the MC501**

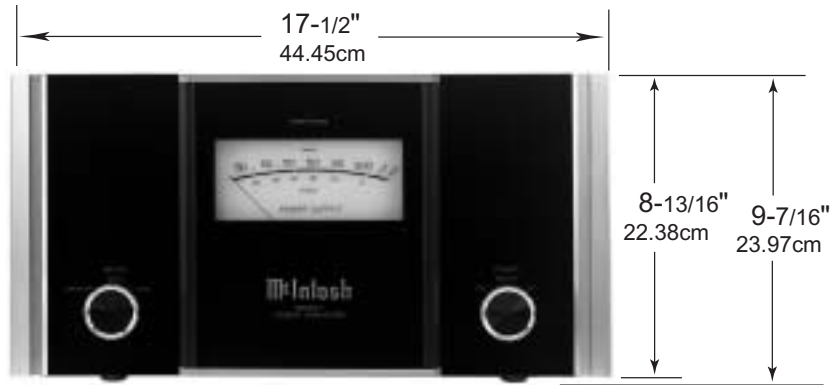

**Rear View of the MC501**

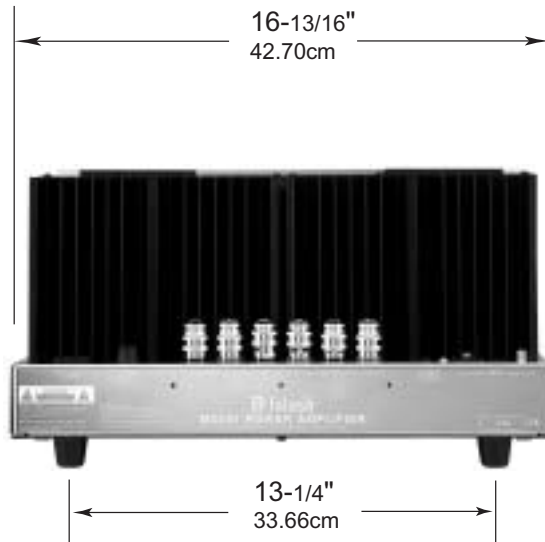

**Side View of the MC501**

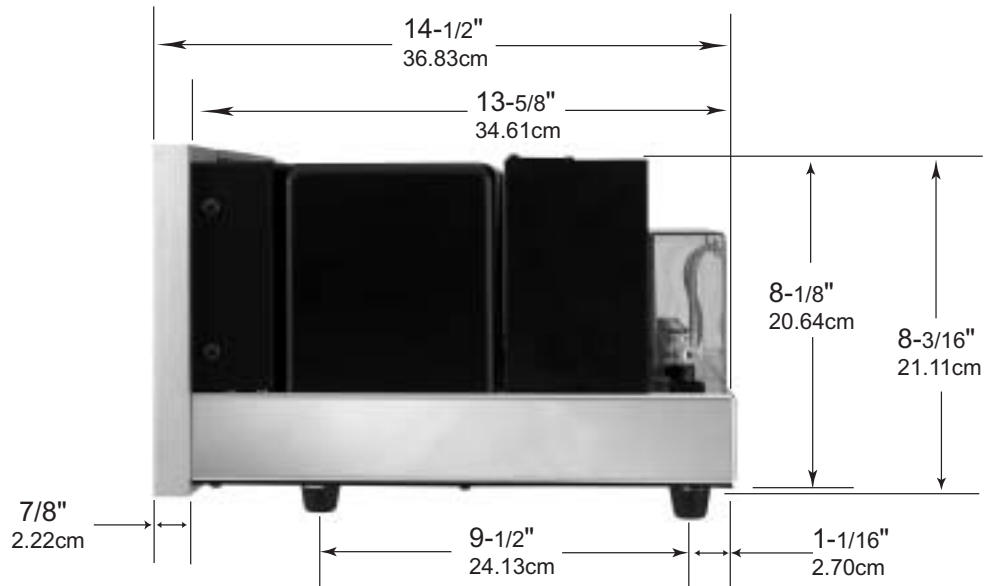

### Installation

**Caution:** The MC501 Amplifier weight is 91.5 pounds (41.5 kilograms). It requires two or more persons to safely handle when moving the amplifier.

The MC501 can be placed upright on a table or shelf, standing on its four feet. The four feet may be removed from the bottom of the MC501 when it is custom installed as outlined below. The four feet together with the mounting screws should be retained for possible future use if the MC501 is removed from the custom installation and used free standing. It also can be custom installed in a piece of furniture or cabinet of your choice. The required panel cutout, ventilation cutout and unit dimensions are shown.

Always provide adequate ventilation for your MC501. Cool operation ensures the longest possible operating life for any electronic instrument. Do not install the MC501 directly above a heat generating component such as a high powered amplifier. If all the components are installed in a single cabinet, a quiet running ventilation fan can be a definite asset in maintaining all the system components at the coolest possible operating temperature.

A custom cabinet installation should provide the following minimum spacing dimensions for cool operation. Allow at least 6 inches (15.24 cm) above the top, 2 inches (3.81cm) below the bottom and 1 inch (2.54 cm) on each side of the amplifier, so that airflow is not obstructed. Allow 16 inches

(40.64 cm) depth behind the front panel. Allow 1-3/16 inches (3.02 cm) in front of the mounting panel for knob clearance. Be sure to cut out a ventilation hole in the mounting shelf according to the dimensions in the drawing.

**MC501 Front Panel  
Custom Cabinet Cutout**

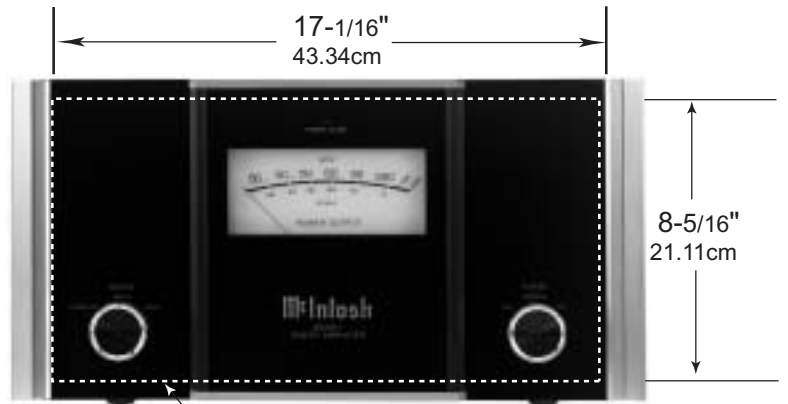

Cutout Opening  
for Custom Mounting

Alternate Rear Foot Location

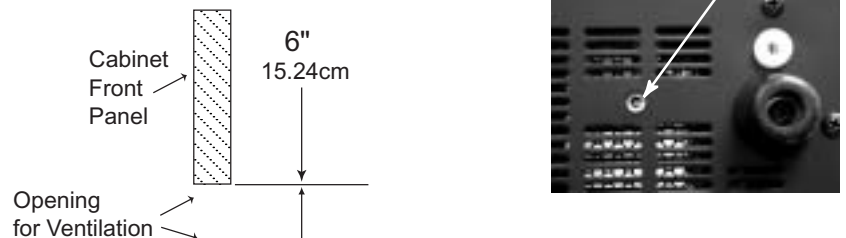

**MC501 Side View  
in Custom Cabinet**

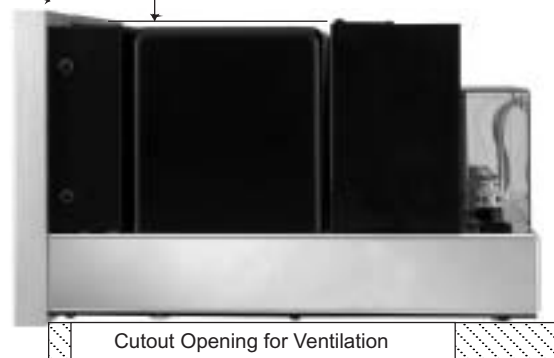

**MC501 Bottom View  
in Custom Cabinet**

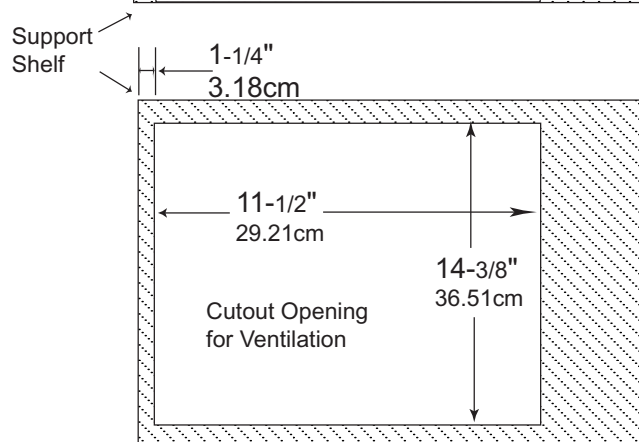

# Top Panel Connections and Switch

Main Fuse holder, refer to information on the back panel of the MC501 to determine the correct fuse size and rating

POWER CONTROL IN receives a turn On/Off Trigger from a McIntosh component. POWER CONTROL OUT sends a turn On/Off Trigger to the next McIntosh component

BALANCED INPUT for an audio cable from a preamplifier or control center audio output

UNBALANCED INPUT for an audio cable from a preamplifier or control center audio output

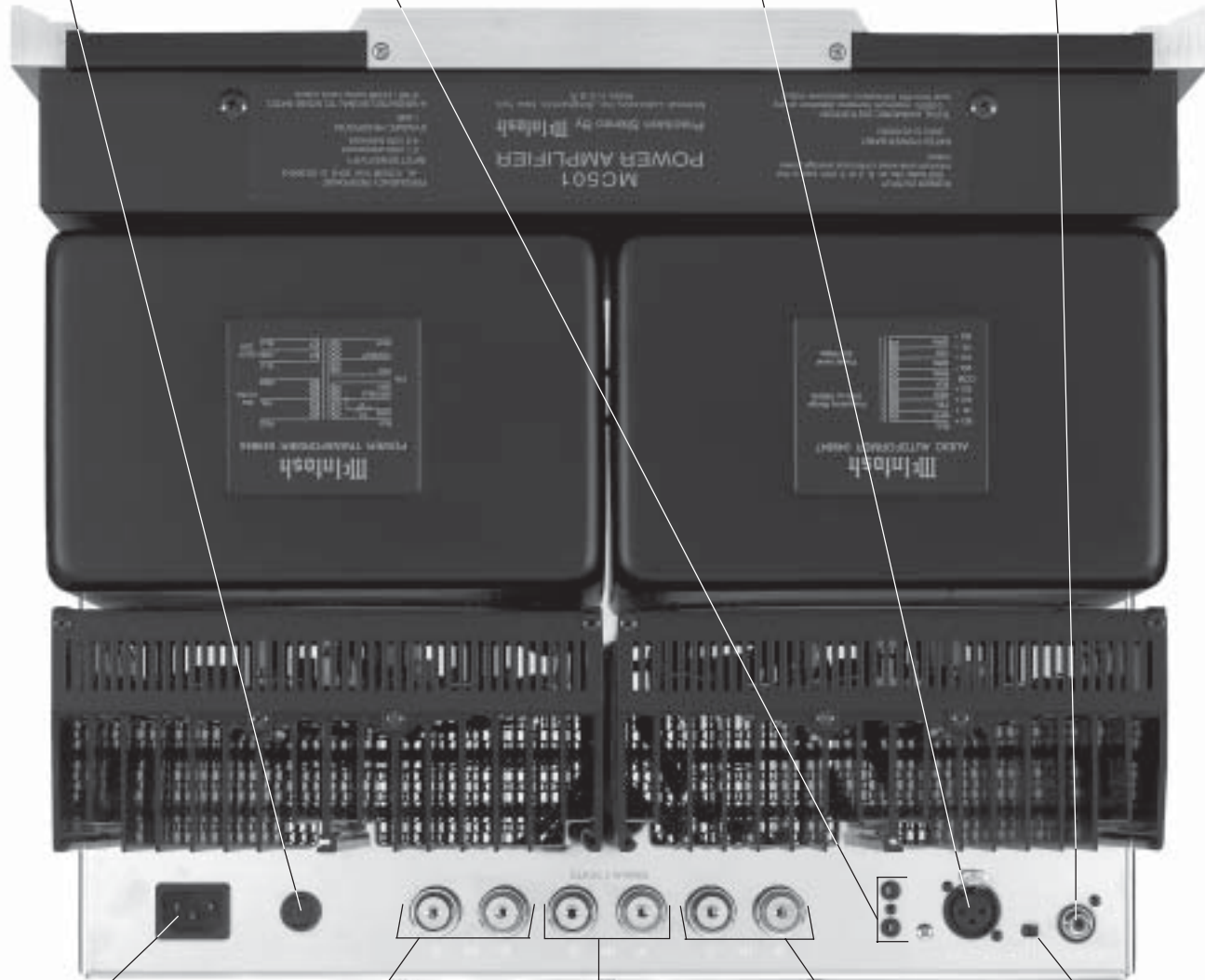

Connect the MC501 power cord to a live AC outlet. Refer to information on the back panel to determine the correct voltage

OUTPUT Connections for 2 ohm loudspeaker

OUTPUT Connections for 4 ohm loudspeaker

OUTPUT Connections for 8 ohm loudspeaker

INPUT MODE switch selects BALANCED or UNBALANCED Input

**Caution: The Loudspeaker ⊖ Negative Connections are above chassis ground. Do not combine any connections together, ground them or connect with another MC501.**

## How to Connect

**Caution:** The supplied AC Power Cord should not be connected to the Rear Panel of the MC501 Amplifier until after the Loudspeaker Connections have been made and the supplied protective Terminal Connections Cover has been installed. Failure to observe this could result in Electric Shock.

1. For Remote Power Control, connect a power control cable from the Control Center or Preamplifier Power Control Out to the MC501 Power Control In.
2. Connect cables from the Unbalanced Output of a McIntosh Preamplifier or Control Center to the MC501 Unbalanced Input.

*Note:* An optional hookup is to use balanced cables.

3. Prepare the Loudspeaker Hookup Cables that attach to the MC501 Power Amplifier by choosing one of the methods below:

### Bare wire cable ends:

Carefully remove sufficient insulation from the cable ends, refer to figures 1, 2 & 3. If the cable is stranded, carefully twist the strands together as tightly as possible.

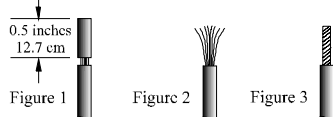

*Note:* If desired, the twisted ends can be tinned with solder to keep the strands together, or attach spade lug and/or banana connector.

### Spade lug or prepared wire connection:

Insert the spade lug connector or prepared section of the cable end into the terminal side access hole, and tighten the terminal cap until the cable is firmly clamped into the terminal so the wires cannot slip out. Refer to figures 4, 5 & 6.

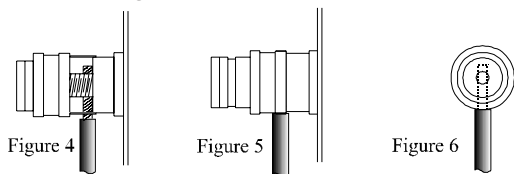

### Banana plug connection:

Insert the banana plug into the hole at the top of the terminal. Tighten the top portion of the terminal post and the set screw to secure the banana plug in place.

*Note:* The use of Banana Plugs is for use in the United States and Canada only.

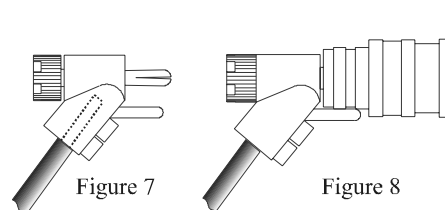

4. Connect the Loudspeaker hookup cables to the output terminals that match the impedance of the Loudspeaker, being careful to observe the correct polarities. Output impedance connections of 2 ohms, 4 ohms and 8 ohms are provided. If the Loudspeaker's impedance is in-between the available connections, use the nearest lower impedance connection.

**WARNING:** Loudspeaker terminals are hazardous live and present a risk of electric shock. For additional instruction on making Loudspeaker Connections contact your McIntosh Dealer or McIntosh Technical Support.

5. Attach the supplied Terminal Connections Cover with the three Mounting Screws (6-32 x 1/4 inch Phillips Head) to the Rear Panel of the MC501 Amplifier. Refer to figure 9.

*Note:* There are two openings on the cover allowing for the Loudspeaker's Cable to exit the MC501.

6. Connect the MC501 power cord to an active AC outlet.

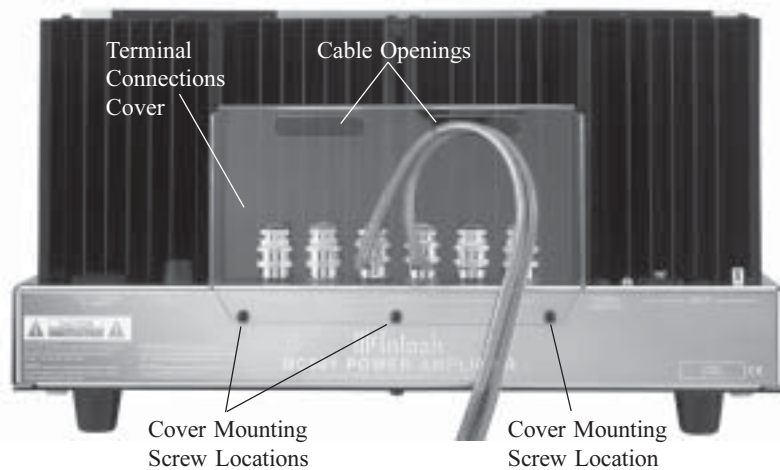
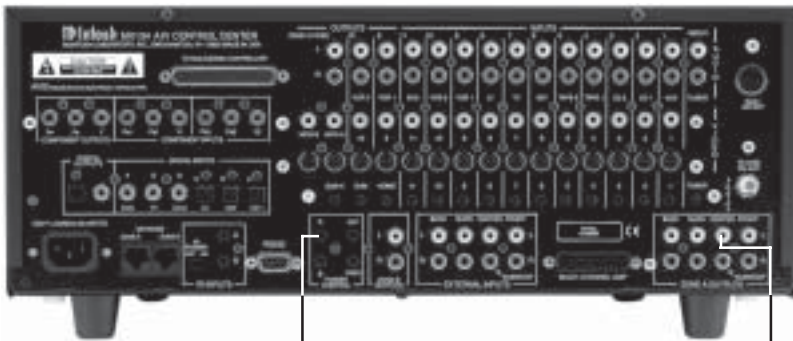

Figure 9



McIntosh MX134 A/V Control Center



MC501 Top Rear View

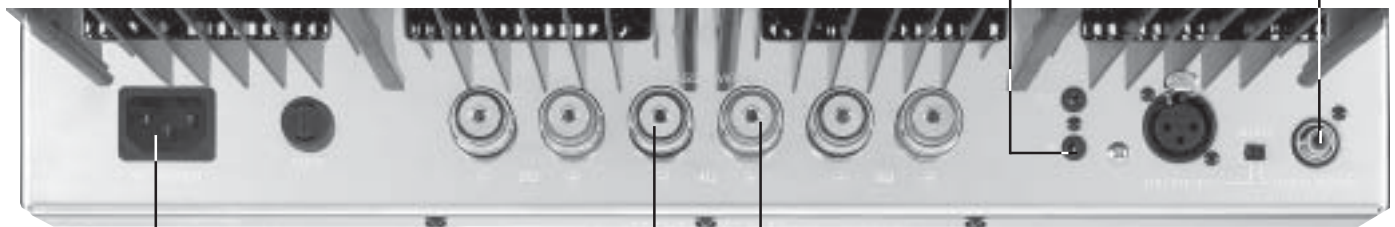

To AC Outlet

4 ohm  
Loudspeaker



**Caution:** The Loudspeaker  $\ominus$  Negative Connections are above chassis ground. Do not combine any connections together, ground them or connect with another MC501.

METER indicates the Power Output of the amplifier

POWER GUARD LED lights when the amplifier POWER GUARD circuit activates



METER Switch selects the display modes of the Power Output Meter

Remote On Indicator lights when the amplifier is in the Remote Turn-On Mode

POWER Switch Turns AC power On/Off, or On/Remote

## How to Operate

### Power On

To have the MC501 automatically turn On or Off when a control center turns on or off, rotate the power switch to the remote position. For manual operation, rotate the power switch to the On or Off position as desired. Refer to figure 10.

*Note: There must be a power control connection between the MC501 and the McIntosh Control Center, in order for the remote power turn on to function.*



Figure 10

### Meter Selection

Rotate the meter mode switch to select the meter operation mode you desire. Refer to figures 11 and 12.

**Lights Off** - Meter lights are turned off and the meter will continue to indicate the power output.

**Watts** - The meter respond to all the musical information being produced by the amplifier. They indicate to an accuracy of at least 95% of the power output with only a single cycle of a 2000Hz tone burst.

**Hold** - The meter pointer is locked to the highest power peak in a sequence of peaks. It is electronically held to this power level until a



Figure 11

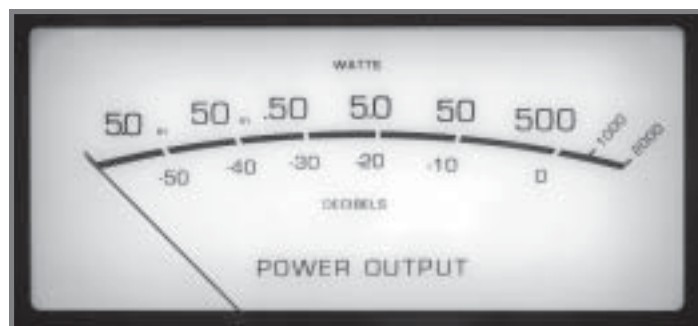

Figure 12

higher power peak passes through the amplifier. The meter pointer will then rise to the newer higher indication. If no further power

peaks are reached, the meter pointer will very slowly return to its rest position or lower power level. The decay rate is approximately 6dB per minute.

*Note: The MC501 Power Output Meter indicates the actual wattage delivered to the Loudspeakers by responding to the combination of current and voltage output.*

### Input Mode Switch

The Input Mode Switch, which is located on the Top Rear Panel of the MC501, allows selection of either the Balanced or Unbalanced Input. Refer to figure 13.



Figure 13

## Technical Description

McIntosh Laboratory, the company who introduced the world's first amplifier that could be called "High Fidelity", has done it again. The McIntosh engineering staff has created a power amplifier without compromise, using the most advanced McIntosh circuit design concepts.

A continuous average power output rating of 500 watts and with an output current of greater than 100 amperes, makes this not only the most advanced, but also one of the most powerful amplifiers McIntosh has ever manufactured. The distortion limits for the MC501 are no more than 0.005% at rated power output for all frequencies from

20Hz to 20,000Hz. Typical performance at mid frequencies is less than 0.002%. The true distortion readings on the MC501 are so low, it takes special measuring techniques to make accurate readings. The MC501 can deliver the best possible performance from any type of high quality Loudspeaker System.

Creating an amplifier with this level of performance did not come easily. Many months of design, testing and measuring were required. Extensive controlled listening tests, the ultimate form of measuring, were made before the final design was accepted.

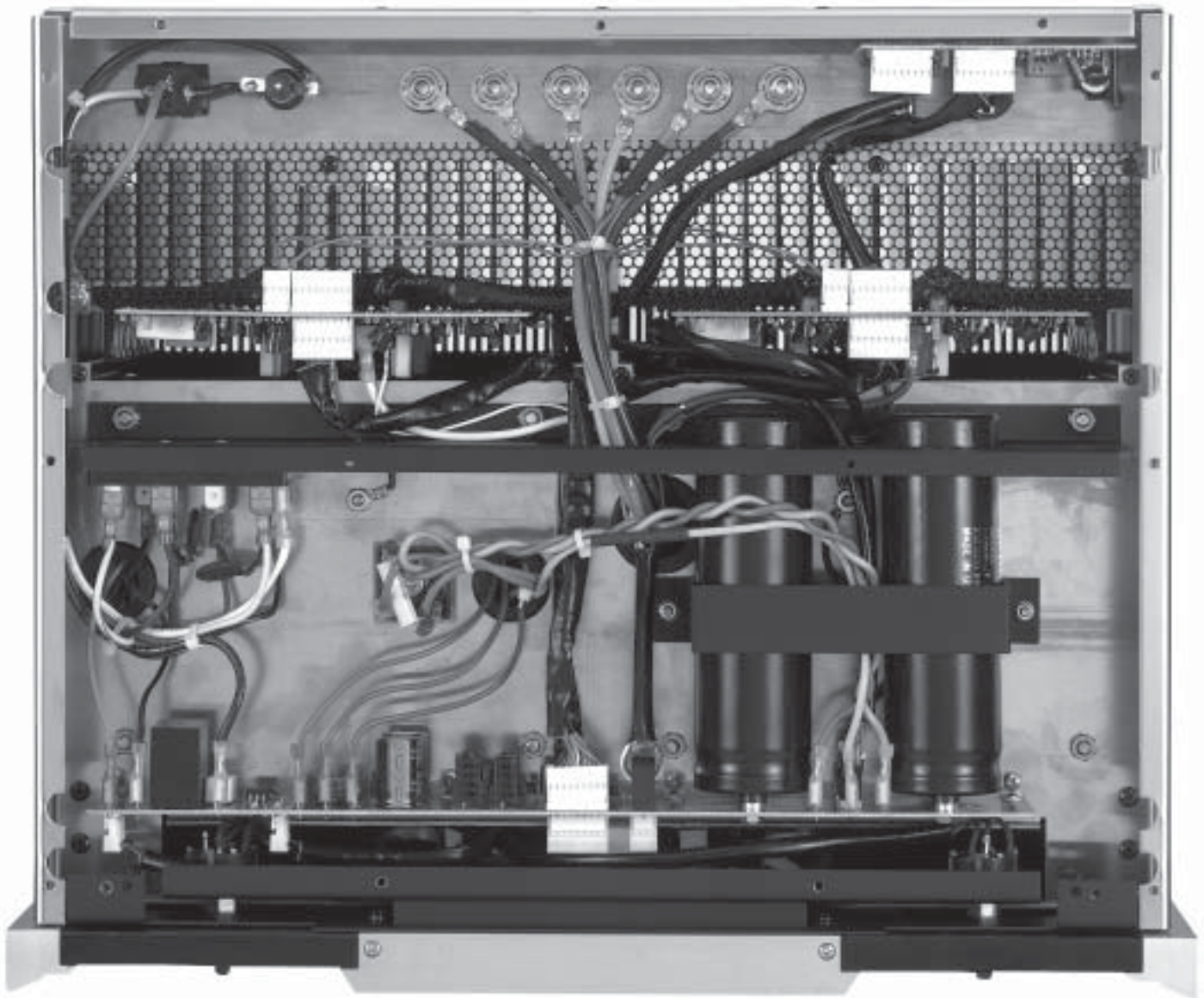

Inside View of the MC501

**Design Philosophy**

The design philosophy incorporated in the MC501 involved several different techniques, all based on sound scientific logic. Every stage of voltage or current amplification must be as linear as possible prior to the use of negative feedback. McIntosh engineers know how to properly design negative feedback circuits so they contribute to the extremely low distortion performance expected from a McIntosh amplifier. The typical McIntosh owner would never accept the approximately 100 times higher distortion of many non-feedback designs.

Double Balanced Push-Pull design is used from input to output. Each half of the amplifier contains complimentary balanced circuitry. The resulting double balanced configuration cancels even order distortion. Refer to figure 14.

All transistors are selected to have nearly constant current gain over the entire current range they must cover. Output transistors in particular, have matched uniform current gain, high current bandwidth product and large active region safe operating area. An automatic tracking bias system completely eliminates any trace of crossover distortion. Precision metal film resistors and low dielectric absorption film capacitors are used in all critical circuit locations.

The output signals of the two balanced circuits are coupled together in the unique McIntosh MC501 Output Autoformer. It provides low distortion power transfer at frequencies from below 20Hz to well beyond 20,000Hz with optimum impedance points of two ohms, four ohms and eight ohms. The unequalled expertise of McIntosh in the design and manufacturing of autoformers is legendary in the high fidelity industry.

The high efficiency circuit design of the MC501 contributes to low operating temperatures. More than 1,045 square inches of heat sink area keep the MC501 operating safely with convection cooling. No fans are needed.

**Autoformers**

All solid state power amplifier output circuits work best into what is called an optimum load. This optimum load may vary considerably from what a loudspeaker requires. In the case of more than one loudspeaker connected in parallel, the load to the power amplifier may drop to two ohms or even less. A power amplifier connected to a load that is lower than optimum, causes more output current to flow, which results in extra heat being generated in the power output stage. This increase in temperature will result in a reduced life expectancy for the amplifier.

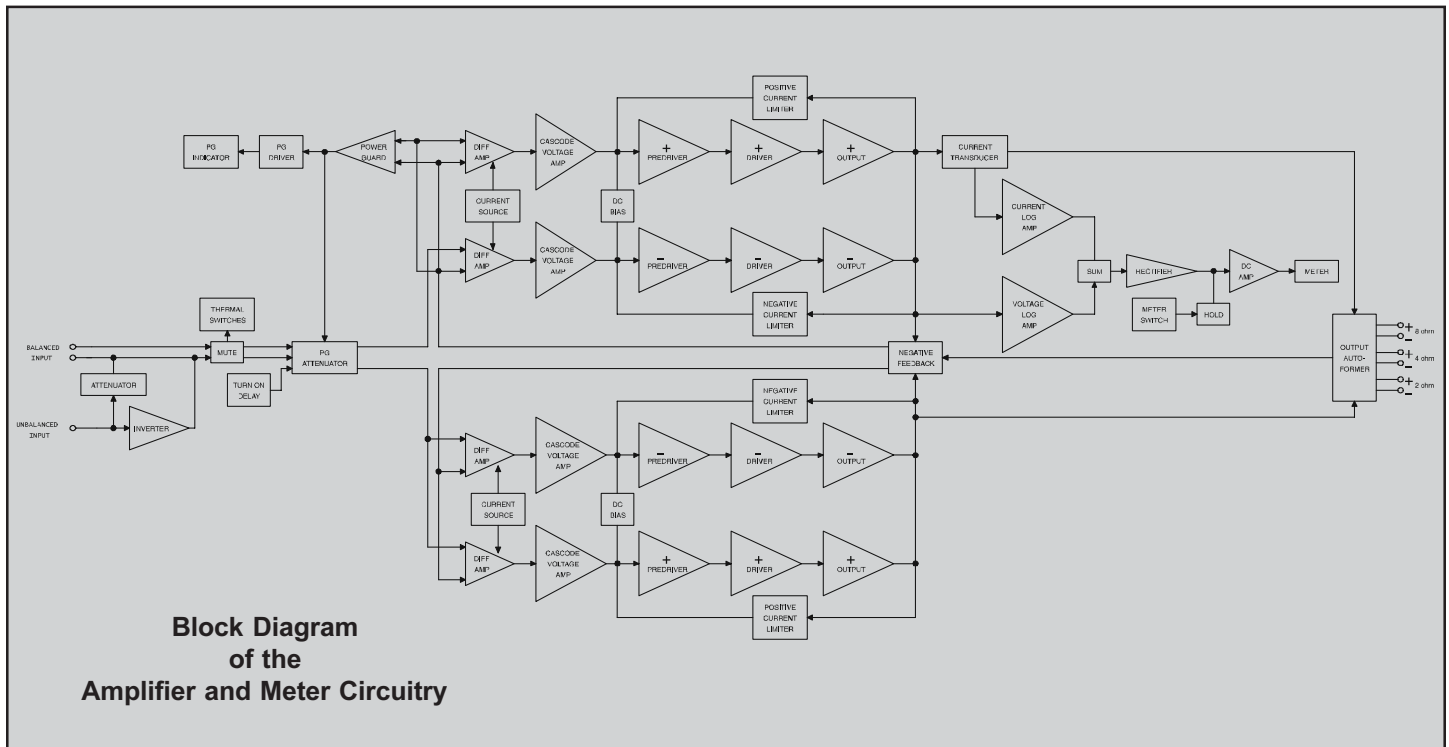

**Block Diagram  
of the  
Amplifier and Meter Circuitry**

Figure 14

The special Balanced Winding Autoformer creates an ideal match between the power amplifier output stage and the loudspeaker. A McIntosh amplifier with an Autoformer can be used to safely drive multiple speakers without reducing the life expectancy of the power amplifier. Refer to figure 15.

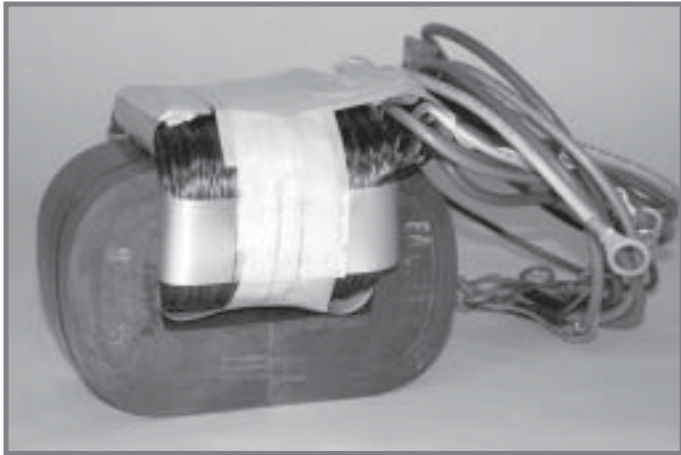

Figure 15

There is absolutely no performance limitation with an Autoformer. Its frequency response exceeds that of the output circuit itself, and extends well beyond the audible range. Its distortion level is so low it is virtually impossible to measure.

In the rare event of a power amplifier output circuit failure, the McIntosh Autoformer provides absolute protection from possible damage to your valuable loudspeakers. The unequalled expertise of McIntosh in the design and manufacturing of Autoformers is legendary in the high fidelity industry. McIntosh engineers know how to do it right.

### Power Output Meter

The McIntosh MC501 has a Output Watt Meter that responds 95% full scale to a single cycle tone burst at 2kHz. Refer to figure 16. Voltage and current output are electronically measured, multiplied and fed to a special circuit that accelerates the pointer movement in the upward direction. When the pointer reaches its peak it pauses only long enough for the human eye to perceive its position, then drops. It is almost 10 times faster than a professional VU meter.

A front panel switch is provided to change the meter to the Watts Hold Mode of operation. This allows fast upward movement of the pointer but greatly increases Hold Time at the peak of its travel. The highest power output of the source material is thus recorded.

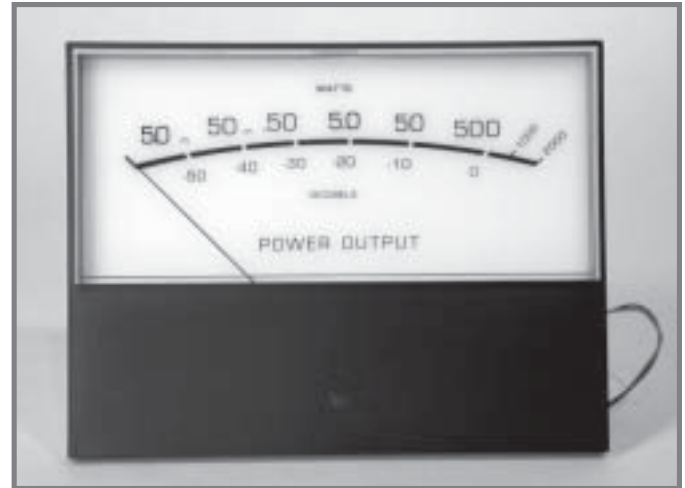

Figure 16

### Protection Circuits

The MC501 incorporates a version of the McIntosh Sentry Monitor Output Transistor Protection Circuit. Refer to Figure 17. There is absolutely no compromise in sonic performance with this

circuit, and it ensures safe operation of the amplifier under even the most extreme operating conditions. The different types of protection circuits incorporated in the MC501 insure a long and safe operating life.

This is just one of the many characteristics of McIntosh Power Amplifiers that make them world famous.

The MC501 also includes the unique patented McIntosh Power Guard circuit.

Power Guard eliminates the possibility of ever overdriving the amplifier into clipping. Refer to figures 18, 19 and 20. An overdriven amplifier can produce both audible and inaudible distortion levels exceeding 40%. The audible distortion is unpleasant to hear, but the inaudible ultrasonic distortion is also undesir-

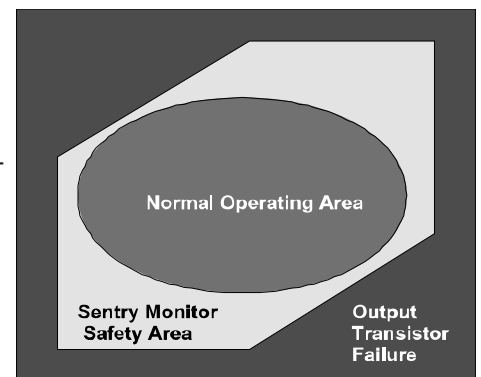

Figure 17

Input Test Signal

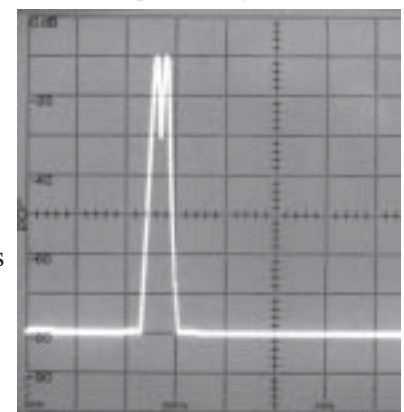

Figure 18

able, since it can damage valuable loudspeaker system tweeters. You will never experience the harsh and damaging distortion due to clipping.

The Power Guard circuit is a waveform comparator, monitoring both the input and output waveforms. Under normal operating conditions, there are no differences between the shape of these waveforms. If an amplifier channel is overdriven, there will be a difference between the two signal waveforms. When the difference exceeds 0.3% (equivalent to 0.3% harmonic distortion), the Power Guard activates the PG light and a dynamic electronic attenuator at the amplifier input reduces the input volume just enough to prevent any further increase in distortion. The Power Guard circuit acts so fast that there are absolutely no audible side effects and the sonic purity of the music reproduction is perfectly preserved. The MC501 Power Amplifier with Power Guard is not limited to just the rated power output, but will actually

Without Power Guard

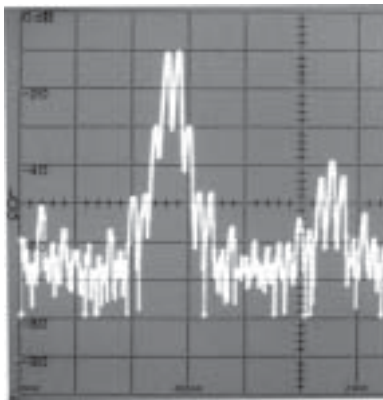

Figure 19

With Power Guard

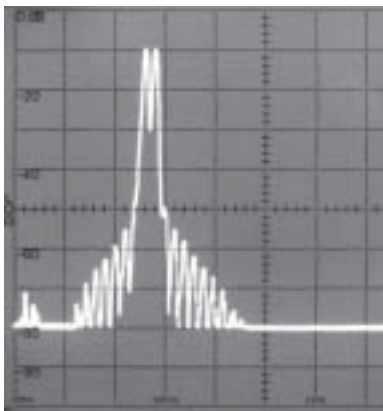

Figure 20

produce distortion free output well above its rated power due to the McIntosh philosophy of conservative design.

**Power Supply Circuits**

To compliment the fully balanced design of the MC501 incorporates a high voltage power supply. Refer to figure 21. High power amplifiers draw high current from the AC power line. Therefore, it is important that they plug directly into the wall outlet.

Also, most owners desire that there be one power switch for the whole audio system. The MC501 is equipped with a circuit that provides remote Power Control from the McIntosh Preamplifier or Control Center. When the Preamplifier or Control Center is switched On, a digital “1” (+5V) signal operates the power relay in the MC501. The MC501 also has a remote Power Control Out Jack. The Power Control signal from this jack is delayed by a fraction of a second so that the turn on power surge of the next power amplifier occurs at a later time. This helps prevent power circuit overload that could trip circuit breakers or blow fuses, a very important feature in a high power Home Theater System employing many MC501 Power Amplifiers.

The MC501 can provide greater than 100 amperes peak output current to drive uneven speaker loads. Some poor speaker designs have input impedance that dip to 1 or 2 ohms at various frequencies and the MC501 has the output current reserve to drive them. It can deliver over 500 Watts Output on tone bursts. The MC501 has huge main filter capacitors that guarantee an excellent signal to noise ratio and the energy storage necessary for the wide dynamic range that “Digital Audio” demands.

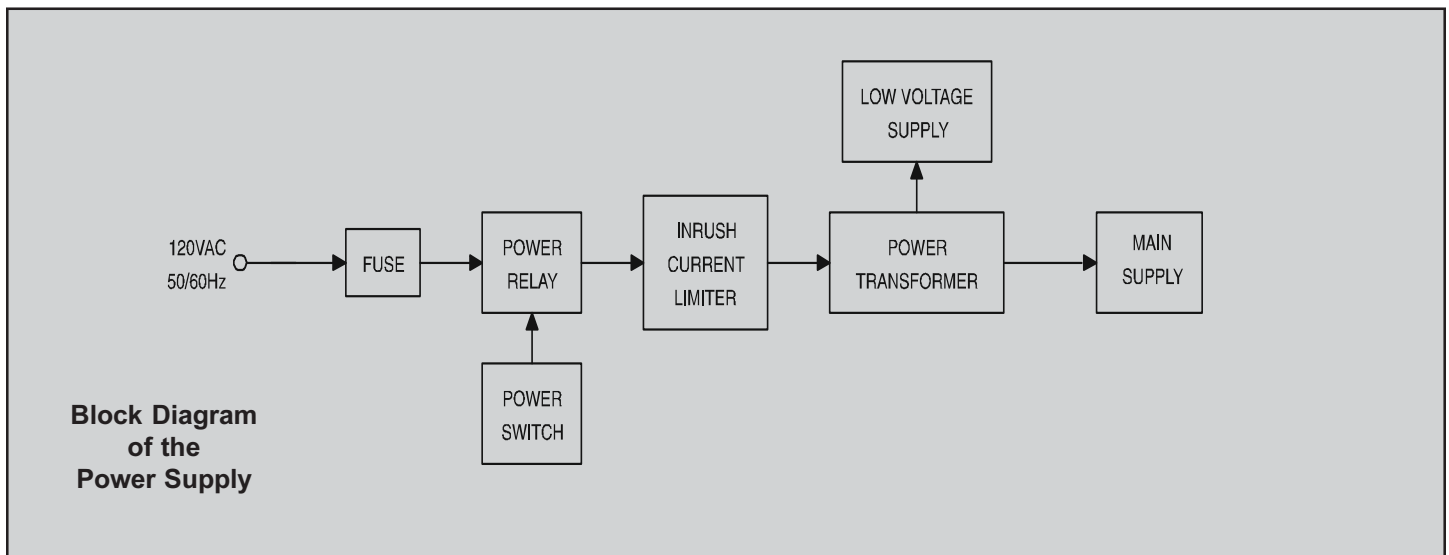
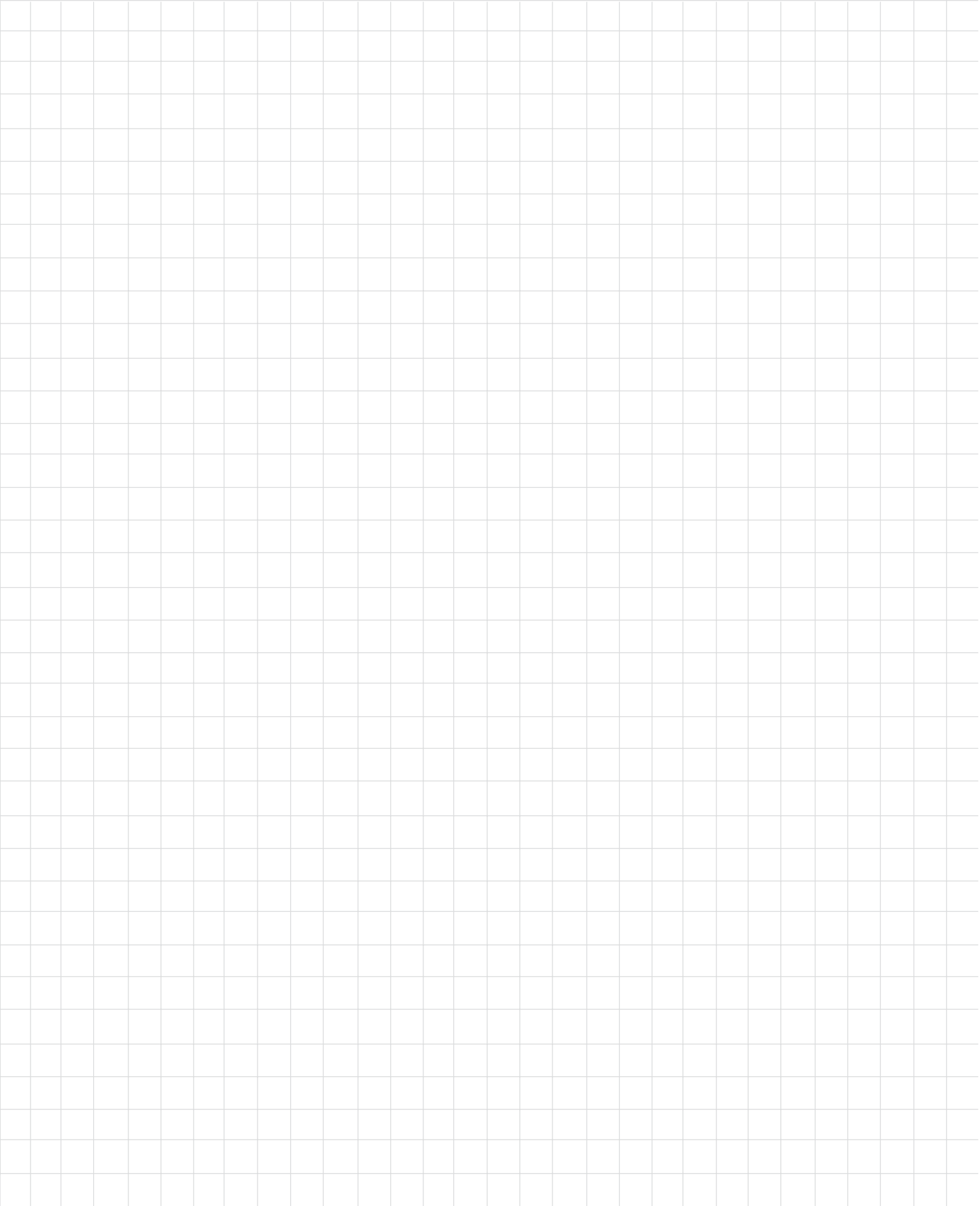
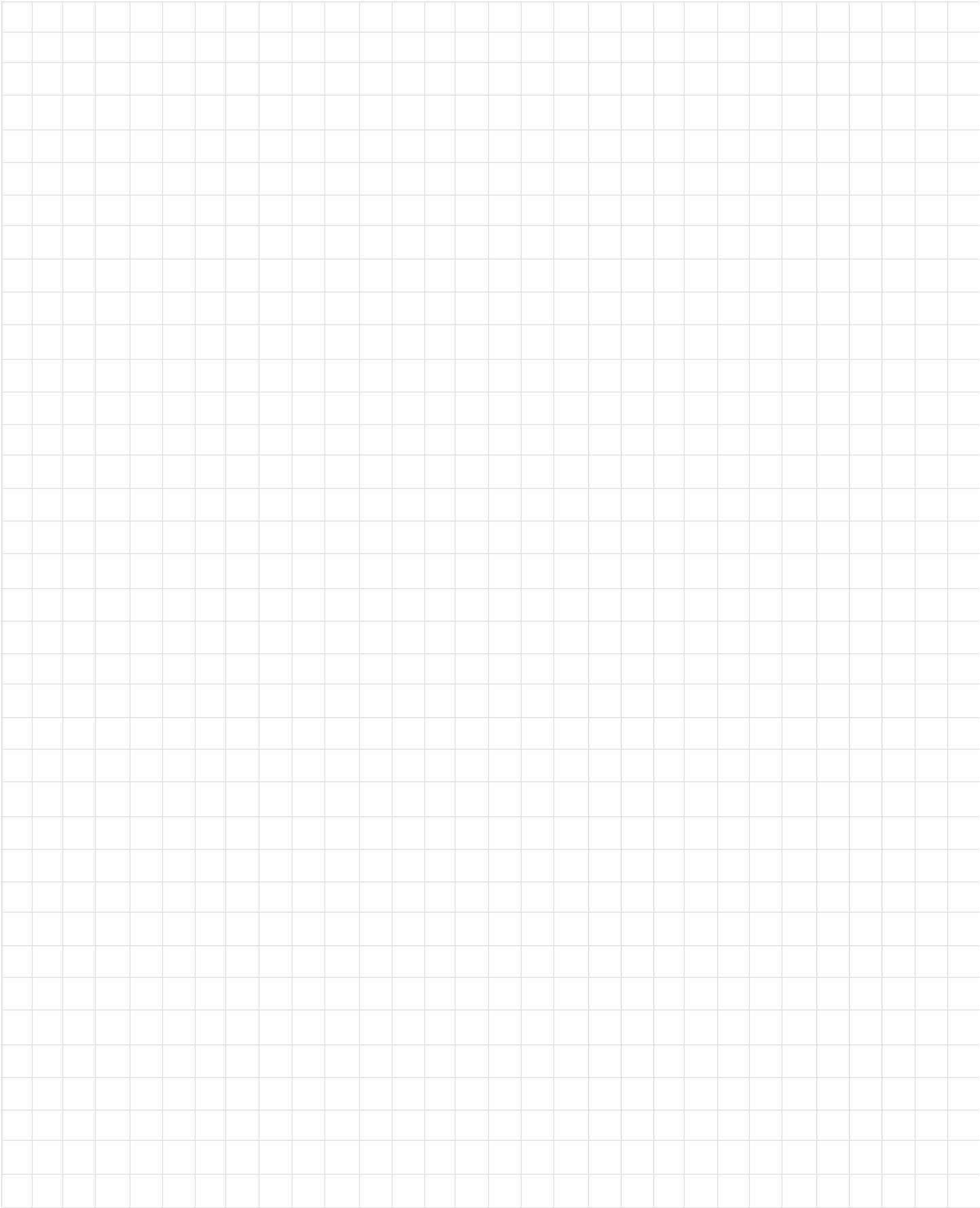

Figure 21







### Specifications

---

#### Power Output

Minimum sine wave continuous average power output is:  
500 watts into 2 ohm load  
500 watts into 4 ohm load  
500 watts into 8 ohm load

#### Rated Power Band

20Hz to 20,000Hz

#### Total Harmonic Distortion

Maximum Total Harmonic Distortion at any power level from 250 milliwatts to rated power output is: 0.005% for 2, 4 or 8 ohm load

#### Dynamic Headroom

1.8dB

#### Frequency Response

+0, -0.25dB from 20Hz to 20,000Hz  
+0, -3dB from 10Hz to 100,000Hz

#### Sensitivity

2.1 Volts Unbalanced Input  
4.2 Volts Balanced Input

#### A-Weighted Signal To Noise Ratio

97dB (124dB below rated output) Unbalanced and Balanced

#### Intermodulation Distortion

Maximum Intermodulation Distortion if instantaneous peak output does not exceed twice the rated output, for any combination of frequencies from 20Hz to 20,000Hz is:  
0.005% for 2, 4 or 8 ohm load

#### Input Impedance

10,000 ohms Unbalanced Inputs  
20,000 ohms Balanced Inputs

#### Wide Band Damping Factor

100 @ 8ohms

#### Power Requirements

100 Volts, 50/60Hz at 8.0 amps  
110 Volts, 50/60Hz at 7.2 amps  
120 Volts, 50/60Hz at 6.6 amps  
220 Volts, 50/60Hz at 3.3 amps  
230 Volts, 50/60Hz at 3.3 amps  
240 Volts, 50/60Hz at 3.3 amps

*Note: Refer to the rear panel of the MC501 for the correct voltage.*

#### Overall Dimensions

Front Panel: 17-1/2 inches (44.45cm) wide, 8-13/16 inches (22.38cm) high. Depth is 14-13/16 inches (37.62cm) including the Front Panel and Knobs

#### Weight

91.5 pounds (41.6 kg) net, 105.5 pounds (48 kg) in shipping carton

**Packing Instructions**

In the event it is necessary to repack the equipment for shipment, the equipment must be packed exactly as shown below. It is very important that the four plastic feet are attached to the bottom of the equipment. Three #10 x 2-1/2 inch screws and washers must be used to fasten the unit securely to the bottom pad and shipping skid. This will ensure the proper equipment location on the bottom pad. Failure to do this will result in shipping damage.

Use the original shipping carton and interior parts only if they are all in good serviceable condition. If a shipping carton or any of the interior part(s) are needed, please call or write Customer Service Department of McIntosh Laboratory. Please see the Part List for the correct part numbers.

Quantity	Part Number	Description
1	034158	Shipping carton only
2	034250	Foam end cap
1	034198	Inner carton top
1	034199	Inner carton bottom
1	034188	Foam pad
1	034037	Inner carton pad
1	033699	Shipping skid
7	017218	Plastic foot
4	100159	#10-32 x 3/4" Machine screw
2	104083	#10 x 7/16" Flat washer
3	101204	#10 x 2-1/2" Wood screw
3	104033	#10 x 1-3/4" Flat washer

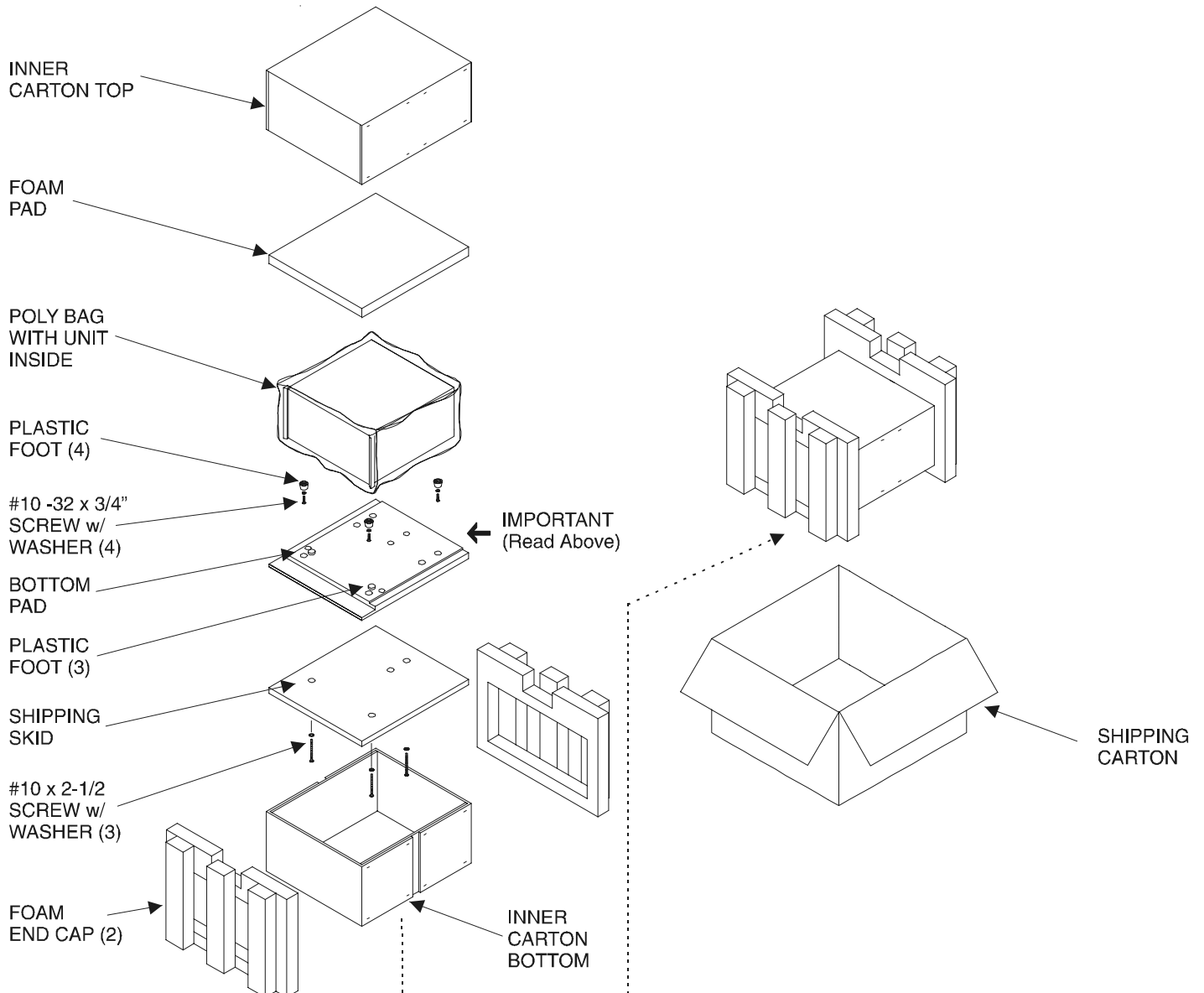



McIntosh Laboratory, Inc.  
2 Chambers Street  
Binghamton, NY 13903

The continuous improvement of its products is the policy of McIntosh Laboratory Incorporated who reserve the right to improve design without notice.

Printed in the U.S.A.

McIntosh Part No. 040856